

Power contactors 16 A and 25 A with or without handle

Cat. N°(s) : 041 14 / 16 / 17 / 23 / 24 / 26 / 27 / 28 / 29 /
31 / 32 / 33 / 34 / 47 / 48 / 58 / 59 and 927 02 / 03

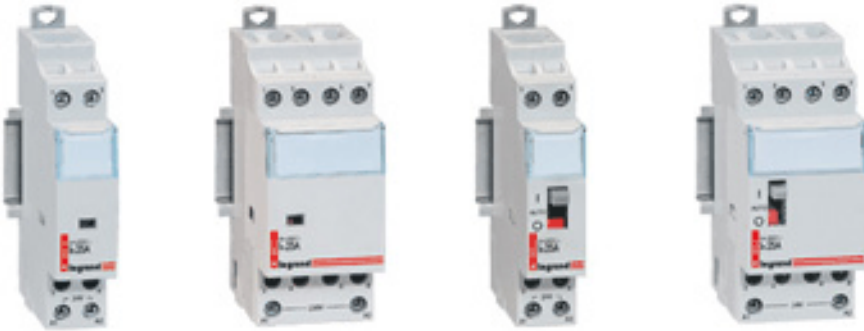

CONTENTS	PAGE
1. Description, use.....	1
2. Range	1
3. Overall dimensions.....	1
4. Preparation - Connection.....	2
5. General characteristics.....	3
6. Conformities and approvals.....	6
7. Auxiliaries.....	5

1. DESCRIPTION - USE

Symbol :

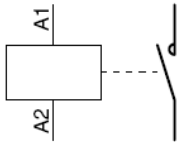

Technology :

. Electromagnetic contactor

Use :

. remote control of a load by the mean of a switch

2. RANGE

Rated thermal current :

. I_{th} = 16 and 25 A

Types of contacts :

. « NO », normally open contact



. « NC », normally closed contact



. Mixed contacts « NO+NC »



Poles :

. Double pole in 1 module (17,8 mm)

- « 2NO »
- « 2NC »
- « NO + NC »

. Four pole in 2 modules (35,6 mm)

- « 4NO »
- « 4NC »
- « 2NO + 2NC »
- « 3NO + 1NC »

2. Range (continued)

Rated voltage (power contacts) :

. U_n = 250 V / 400 V ~

Rated control voltage :

. 24 V and 230 V ~

Rated frequency, power and control :

. 50 / 60 Hz

3. OVERALL DIMENSIONS

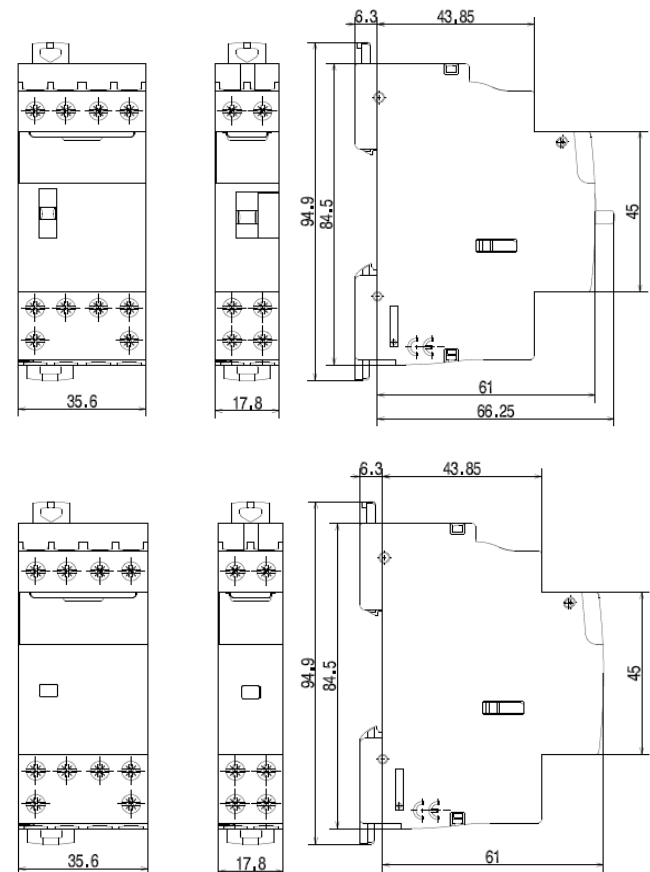

Power contactors 16 A and 25 A with or without handle

Cat. N°(s) : 041 14 / 16 / 17 / 23 / 24 / 26 / 27 / 28 / 29 /
31 / 32 / 33 / 34 / 47 / 48 / 58 / 59 and 927 02 / 03

4. PREPARATION - CONNECTION

Installation software :

. XL PRO

Operational positions :

. Vertical, horizontal, upside down, on the side

Fixing :

. On symmetrical rail EN 50-055 or DIN 35 by the mean of two plastic clamps.

Recommended tools :

. For terminal screws : screwdriver, insulated or not, Pozidriv n°1 or plate (4mm wide).
. For fixing : Pozidriv n°1 or plate (5.5 mm max) screwdriver

Position in a row :

. Due to the location of the terminals and the profile of the device, single phase and three phase prong busbars can go through the contactor without disturbing access to contactors top terminals. Whatever the place of the contactor in the row, M.C.B.'s installed on the same rail can be supplied by a prong busbar topside

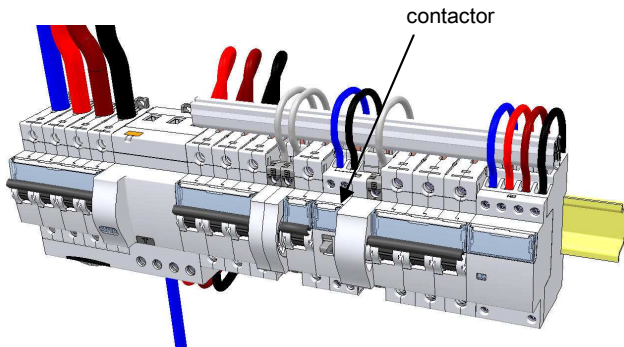

Examples of wiring diagrams :

. Contactor « 2 NO »

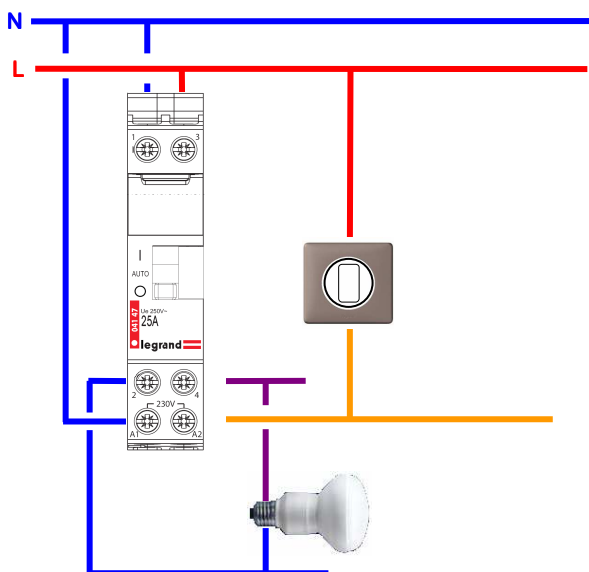

4. PREPARATION - CONNECTION (continued)

. Contactor « 3 NO »

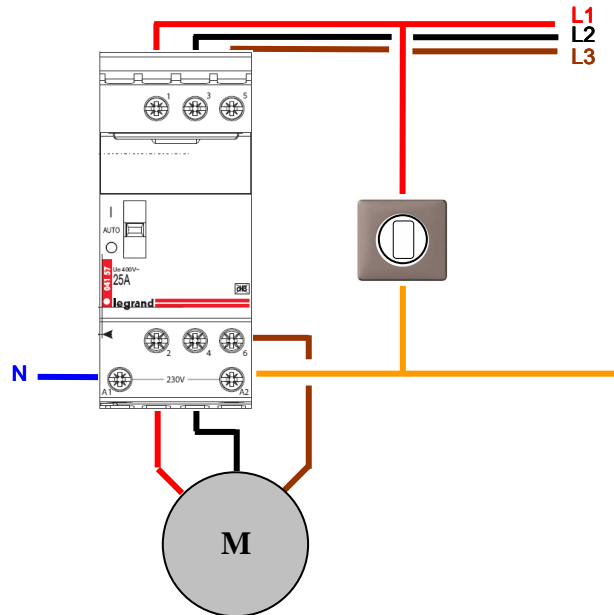

. Contactor « 4 NO »

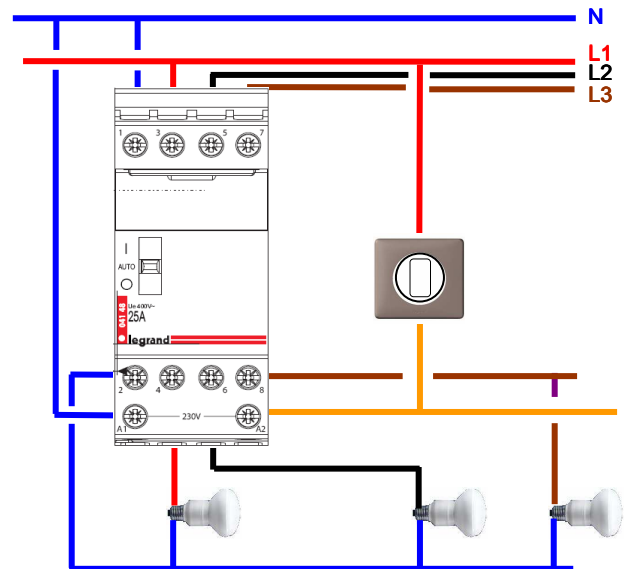

Power contactors 16 A and 25 A with or without handle

Cat. N°(s) : 041 14 / 16 / 17 / 23 / 24 / 26 / 27 / 28 / 29 /
31 / 32 / 33 / 34 / 47 / 48 / 58 / 59 and 927 02 / 03

4. PREPARATION - CONNECTION *(continued)*

Connection :

- . Control and power screw terminals :
 - Type of terminal : cage terminals
 - Terminal depth : 12 mm
 - Terminal capacity (h x w) : 4.7 x 4.7 mm
 - Copper cables
- Rigid : 1 x (0.75 to 6 mm²) or 2 x (0.75 to 2.5 mm²)
- Flexible without ferrule : 1 x (0.75 to 6 mm²) or 2 x (0.75 to 2.5 mm²)
- Flexible with single ferrule : 1 x (0.75 to 6 mm²)
- Flexible with double ferrule : 1 x (0.75 to 4 mm²)
 - Screw head type: mixed, Posidriv n° 1 and slotted 4mm
 - Type of screw : M3,5
 - Tightening torque : mini = 0.5 Nm / max = 1.2 Nm / recommended : 0.8 Nm

Length of control lines :

- . 24 V contactor : 330 m (1 module contactor) or 100 m (2 module contactor) with 1.5 mm² copper wire
- . 230 V contactor : 250 m (1 module contactor) or 400 m (2 module contactor) whatever the wire cross-section.

Protection degree :

- . Terminal ingress protection : IP2x (device connected)
- . Front face ingress protection : IP3XD
- . Classe II, front face behind a cabinet faceplate
- . Protection against mechanical shocks : IK04

Shaking resistance :

- . No change of contact state during shaking test in accordance with EN 60898 standard

Manual actuation :

- . By ergonomic 3 position (I, auto, O) handle when contactor is equipped with
 - Position « I » : permanent control ON
 - Position « O » : permanent control OFF
 - Position « auto » : electric control by switch

Display of contacts state :

- . By orange indicator when manual or electric control is on

Labelling :

- . Circuit may be labelled by the mean of the label holder on the front face of the latching relay

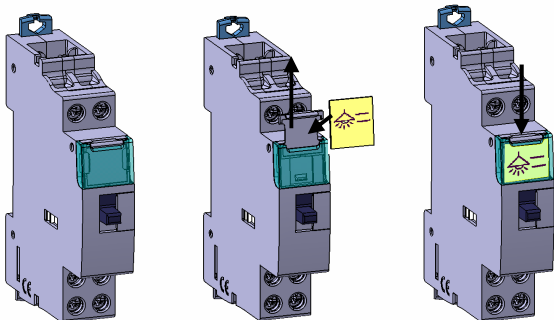

5. GENERAL CHARACTERISTICS

Marking :

- By permanent ink pad printing :
- . Front face :

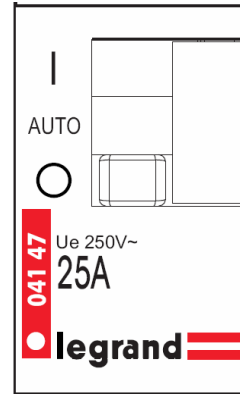

Top face : certification logos, electric diagram

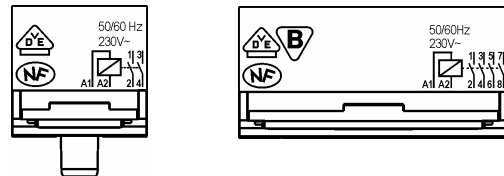

. Terminals :

1 to 8 : supply and load / A1 et A2 : control
Upper terminals

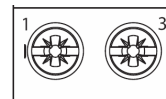

Lower terminals

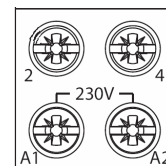

Isolation :

- . > 3 mm in compliance with EN 61095 standard

Isolation rated voltage (Ui) :

- . Single pole / Double pole : 250 V~
- . Triple pole / Four pole : 400 V~

Pollution degree :

- . 2 according to EN 61095 standard

Isolation voltage between control and load :

- . 4 000 V.

Rated impulse withstand voltage (Uimp) :

- . 4 kV

Power contactors 16 A and 25 A with or without handle

Cat. N°(s) : 041 14 / 16 / 17 / 23 / 24 / 26 / 27 / 28 / 29 /
31 / 32 / 33 / 34 / 47 / 48 / 58 / 59 and 927 02 / 03

5. GENERAL CHARACTERISTICS (continued)

Withstand to electromagnetic disturbances (EMC) :

. Schock wave 1,2 / 50 μ s : class 4 (2 kV between lines, 4 kV between line and earth)

Influence of altitude :

. no effect up to 2 000 m

Rated frequency :

. 50 / 60 Hz

Rated current for each category of use (Ie) :

. AC7a or AC1 (heating) : Ie = 16 A or 25 A depending on the cat. n°
. AC7b or AC3 (motor control) : Ie = 10 A (2.2 kW for 2NO contactor and 4 kW for 4 NO contactor) for 25A contactors and Ie = 6.5 A for 16A contactors

Operation rated voltage (Ue) :

. Ue = 250 V ~ for single pole and double pole
. Ue = 400 V ~ for triple pole and four pole

Protection against short-circuits :

. Conditionnal short-circuit current Iq = 6 000 A according to EN 61095 standard
. Maximum thermal stress : 16 000 A²s
. To protect 16 A and 25 A contactors against short-circuits in accordance with conditionnal current Iq = 6 000 A (EN 61095 standard), we recommend to use a rated current \leq 25 A M.C.B. or gG fuse.

Control voltage (Uc) :

. Uc = 230 V~ or 24 V~

Operating control voltage :

. from 0.85 to 1.1 Uc

Release control voltage :

. from 0.2 to 0.75 Uc

Control impulse time :

. 100 ms mini

Rated duty :

. Intermittent duty : 600 operating cycles per hour according to EN 61095 standard (class 600)

Force by handle operation :

. 1000 g for closing and opening operation

Endurance :

In number of operating cycles (ON + OFF)

. Control by handle : 500 operating cycles

. Electrical control :

- 1 000 000 operating cycles with no load
- 100 000 operating cycles at Ie AC-7a in accordance with EN 61095 (same at Ie AC1)
- 150 000 operating cycles at Ie AC-7b in accordance with EN 61095 (same at Ie AC3)

Operation under 400 Hz :

. not possible

5. GENERAL CHARACTERISTICS (continued)

Use with Direct Current (DC) :

. Control : do not operate with DC

. Power circuit : NO and NC contacts may be used to control loads supplied with DC in accordance with the table of max current below

Ue	DC 1 (resistiv load)			DC 3 (motors)		
	number of poles in series			number of poles in series		
	1 p	2 p	3 p	1 p	2 p	3 p
8 V=	25 A	25 A	25 A	21.5 A	25 A	25 A
12 V=	25 A	25 A	25 A	20 A	25 A	25 A
24 V=	25 A	25 A	25 A	16 A	25 A	25 A
48 V=	21 A	25 A	25 A	8 A	18 A	25 A
110 V=	7 A	16 A	25 A	1.6 A	6.5 A	16 A

Control consumption :

Type of contact	Control voltage	Current in mA (at Un)	
		sustain	inrush
2 NO / NO + NC	24 V~	200	970
4 NO		300	2500
2 NO	230 V~	12	60
2 NC		20	90
NO + NC		20	90
4 NO		20	200

Type of contact	Control voltage	Power in W (at Un)
		sustain
2 NO / NO + NC	24 V~	1.4
4 NO		2.1
2 NO	230 V~	0.8
2 NC		1.2
NO + NC		1.2
4 NO		1.3

Average dissipated power per contact at 230V :

. 0,8 W per contact of 16 A contactor

. 1,8 W per contact of 25 A contactor

Annual energy consumption of contactors :

. Loads supplied in 230/400V 50Hz network

. Global energy consumption, control + power contacts, with an « average » use.

Type of contact	Control voltage	in kWh (at Un)
NO + NC	24 V~	4
2 NO		4.8
4 NO		7.6
2 NO	230 V~	3.1
2 NC		1.0
NO + NC		3.4
4 NO		5.4
4 NC		2.0
2 NO + 2 NC		4.4

Power contactors 16 A and 25 A with or without handle

Cat. N°(s) : 041 14 / 16 / 17 / 23 / 24 / 26 / 27 / 28 / 29 /
31 / 32 / 33 / 34 / 47 / 48 / 58 / 59 and 927 02 / 03

5. GENERAL CHARACTERISTICS (continued)

Noise (holding) :

. ≤ 45 dB at 1 cm

Operating temperatures :

. A standard contactor is set to operate at its rated current (16 A or 25 A) in an ambient temperature of + 30°C

. In order to limit overheating, we recommend to use a spacing element (cat. n° 044 40)

- Every 2 contactors if the ambient temperature ≤ 40°C
- Every contactors if the ambient temperature > 40°C

. Depending on ambient temperature, deratings below must be used :

- from - 25°C to + 40°C, no derating
- from + 40°C to + 60°C derating as in table below

Contactor rated current	40°C	50°C	60°C
Ie = 16 A	16 A	14 A	13 A
Ie = 25 A	25 A	22 A	20 A

Storage temperature :

. from - 40°C up to + 70°C

Moulded case material :

. Polyamid

Characteristics of the plastic material :

. Resistance to glow wire test during 30 s according to IEC 60669-2-2 (§24.1) :

- Handle : 650°C
- Other components : 850°C

Weight :

. 0.120 kg per single pole / double pole device

. 0.230 kg per triple pole / four pole device

Packaged volume :

. 0.2 dm³ for single pole and double pole individually packaged units

. 1.6 dm³ for single pole and double pole units packaged per 10

. 0.4 dm³ for triple pole and four pole individually packaged units

Contactors choice table :

For a life time of 10 years with 200 days of annual use

. Heating

Maximum power according to the number of operations per day (kW)						
Number of operations per day	≤ 50	75	100	250	500	
230 V~ single phase heating	16 A	3.6	2.8	2.4	1.6	0.8
	25 A	5.6	4.4	3.7	2.5	1.25
400 V~ three phase heating	25 A	16	13.7	11.3	5	3.7

. Motors (AC-7b)

230 V~ single phase motor	16 A	1.5
	25 A	2.3
400 V~ three phase motor	25 A	4

5. GENERAL CHARACTERISTICS (continued)

. Lighting

Maximum number of lamps per contact of the contactor in 230 V~ single phase network and 400 V~ three phase and neutral network.

. In 230 V~ three phase network with no neutral, values of the table must be divided by $\sqrt{3}$.

- Incandescent lamps

Tungsten filament 230 V~ and low voltage halogen				
Unit power	40 W	60 W	75 W	100 W
16 A	45	30	24	19
25 A	60	48	38	30

Tungsten filament 230 V~ and low voltage halogen (continued)				
Unit power	150 W	200 W	500 W	1000 W
16 A	13	10	4	2
25 A	20	15	6	3

Very Low Voltage halogen lamps with ferromagnetic ballast						
Unit power	20 W	35 W	50 W	75 W	100 W	150 W
16 A	32	20	15	12	9	6
25 A	52	30	24	16	12	8

Very Low Voltage halogen lamps with electronic ballast						
Unit power	20 W	35 W	50 W	75 W	100 W	150 W
16 A	60	40	28	18	14	9
25 A	80	50	40	26	20	13

- Fluorescent lamps with ferromagnetic ballast

Single parallel compensated					
Unit power	18 W	20 W	36 W	58 W	115 W
16 A	24	24	16	11	5
25 A	33	30	25	17	9

Twin serial compensated					
Unit power	2 x 20 W	2 x 36 W	2 x 40 W	2 x 58 W	2 x 140
16 A	30	24	22	15	6
25 A	45	38	35	24	10

Four serial compensated	
Unit power	4 x 18 W
16 A	16
25 A	24

Compact with integrated starter				
Unit power	7 W	10 W	18 W	26 W
16 A	50	40	28	19
25 A	60	50	42	28

Power contactors 16 A and 25 A with or without handle

Cat. N°(s) : 041 14 / 16 / 17 / 23 / 24 / 26 / 27 / 28 / 29 /
31 / 32 / 33 / 34 / 47 / 48 / 58 / 59 and 927 02 / 03

5. GENERAL CHARACTERISTICS (continued)

- Fluorescent lamps with electronic ballast

Single				
Unit power	18 W	30 W	36 W	58 W
16 A	72	42	36	22
25 A	110	68	58	36

Twin			
Unit power	2 x 18 W	2 x 36 W	2 x 58 W
16 A	36	20	12
25 A	56	30	19

Triple serial compensated		
Unit power	3 x 14 W	3 x 18 W
16 A	34	26
25 A	46	38

Four serial compensated		
Unit power	4 x 14 W	4 x 18 W
16 A	26	20
25 A	37	28

With integrated electronic supply					
Unit power	7 W	11 W	15 W	20 W	23 W
16 A	120	80	64	50	43
25 A	200	125	90	70	60

- Discharge lamps with compensator

Metal halide						
Unit power	35 W	70 W	100 W	150 W	250 W	400 W
16 A	10	6	5	3	2	1
25 A	15	9	7	5	3	2

Low pressure sodium						
Unit power	18 W	35 W	55 W	90 W	135 W	180 W
16 A	12	6	5	3	2	2
25 A	20	10	7	5	3	3

High pressure sodium					
Unit power	70 W	150 W	250 W	400 W	1000 W
16 A	8	7	5	3	1
25 A	10	9	6	4	2

High pressure mercury					
Unit power	50 W	80 W	125 W	250 W	400 W
16 A	11	8	6	3	2
25 A	15	10	8	4	3

Mixed high pressure				
Unit power	100 W	160 W	250 W	400 W
16 A	9	6	4	2
25 A	11	7	5	3

6. CONFORMITIES AND APPROVALS

Compliance :

. EN 61095 / NFC 61-480 – CEI 61095

Certificates :

. NF (France)
. VDE (Germany)
. BBJ (Poland)
. GOST (Russia)

Tropicalization :

. execution 2 (all climates) according to U.T.E. C 63-100 guide

Environment :

. complying with RoHS
. without halogen

7. AUXILIARIES

Auxiliaries :

. Signalling change-over switch NO+NC auxiliaries cat. n° 041 83 and 041 85.
- Cat. n° 041 85 fits double pole contactors, one module wide
- Cat. n° 041 83 fits triple pole and four pole contactors, two module wide.
- Used to indicate the position status of the contacts of the product with which it is associated.

Association of the auxiliaries :

. Auxiliaries are fitted on left hand side of contactor

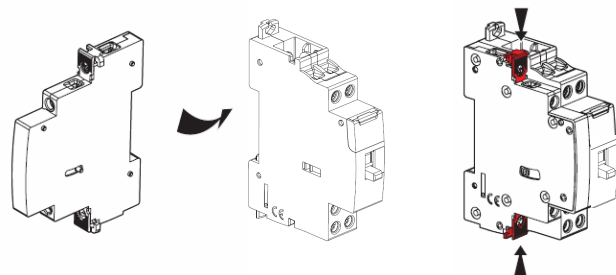

. Maximum of 2 change-over switch auxiliaries per contactor
- cat. n° 041 85

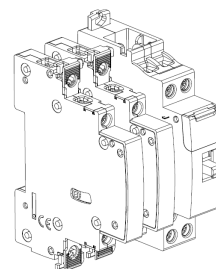

- cat. n° 041 83

